

Mehanički programski prekidač MPS

HR Upute za montažu

159828-03



Germany
 GEZE Sonderkonstruktionen GmbH
 Planken 1
 97944 Boxberg-Schweigern
 Tel. +49 (0) 7930 9294 0
 Fax +49 (0) 7930 9294 10
 E-Mail: sk.de@geze.com
 GEZE GmbH
 Niederlassung Süd-West
 Tel. +49 (0) 7152 203 594
 E-Mail: leonberg.de@geze.com
 GEZE GmbH
 Niederlassung Süd-Ost
 Tel. +49 (0) 7152 203 6440
 E-Mail: muenchen.de@geze.com
 GEZE GmbH
 Niederlassung Ost
 Tel. +49 (0) 7152 203 6840
 E-Mail: berlin.de@geze.com
 GEZE GmbH
 Niederlassung Mitte/Luxemburg
 Tel. +49 (0) 7152 203 6888
 E-Mail: frankfurt.de@geze.com
 GEZE GmbH
 Niederlassung West
 Tel. +49 (0) 7152 203 6770
 E-Mail: essen.de@geze.com
 GEZE GmbH
 Niederlassung Nord
 Tel. +49 (0) 7152 203 6600
 E-Mail: hamburg.de@geze.com
 GEZE Service GmbH
 Tel. +49 (0) 1802 923392
 E-Mail: service-info.de@geze.com

Austria
 GEZE Austria
 E-Mail: austria.at@geze.com
 www.geze.at

Baltic States
 GEZE GmbH Baltic States office
 E-Mail: office-latvia@geze.com
 www.geze.com

Benelux
 GEZE Benelux B.V.
 E-Mail: benelux.nl@geze.com
 www.geze.be
 www.geze.nl

Bulgaria
 GEZE Bulgaria - Trade
 E-Mail: office-bulgaria@geze.com
 www.geze.bg

China
 GEZE Industries (Tianjin) Co., Ltd.
 E-Mail: chinasales@geze.com.cn
 www.geze.com.cn

GEZE Industries (Tianjin) Co., Ltd.
 Branch Office Shanghai
 E-Mail: chinasales@geze.com.cn
 www.geze.com.cn

GEZE Industries (Tianjin) Co., Ltd.
 Branch Office Guangzhou
 E-Mail: chinasales@geze.com.cn
 www.geze.com.cn

GEZE Industries (Tianjin) Co., Ltd.
 Branch Office Beijing
 E-Mail: chinasales@geze.com.cn
 www.geze.com.cn

France
 GEZE France S.A.R.L.
 E-Mail: france.fr@geze.com
 www.geze.fr

Hungary
 GEZE Hungary Kft.
 E-Mail: office-hungary@geze.com
 www.geze.hu

Iberia
 GEZE Iberia S.R.L.
 E-Mail: info@geze.es
 www.geze.es

India
 GEZE India Private Ltd.
 E-Mail: office-india@geze.com
 www.geze.in

Italy
 GEZE Italia S.r.l
 E-Mail: italia.it@geze.com
 www.geze.it

GEZE Engineering Roma S.r.l
 E-Mail: roma@geze.biz
 www.geze.it

Poland
 GEZE Polska Sp.z o.o.
 E-Mail: geze.pl@geze.com
 www.geze.pl

Romania
 GEZE Romania S.R.L.
 E-Mail: office-romania@geze.com
 www.geze.ro

Russia
 OOO GEZE RUS
 E-Mail: office-russia@geze.com
 www.geze.ru

Scandinavia – Sweden
 GEZE Scandinavia AB
 E-Mail: sverige.se@geze.com
 www.geze.se

Scandinavia – Norway
 GEZE Scandinavia AB avd. Norge
 E-Mail: norge.se@geze.com
 www.geze.no

Scandinavia – Denmark
 GEZE Danmark
 E-Mail: danmark.se@geze.com
 www.geze.dk

Singapore
 GEZE (Asia Pacific) Pte, Ltd.
 E-Mail: gezesea@geze.com.sg
 www.geze.com

South Africa
 GEZE Distributors (Pty) Ltd.
 E-Mail: info@gezesa.co.za
 www.geze.co.za

Switzerland
 GEZE Schweiz AG
 E-Mail: schweiz.ch@geze.com
 www.geze.ch

Turkey
 GEZE Kapi ve Pencere Sistemleri
 E-Mail: office-turkey@geze.com
 www.geze.com

Ukraine
 LLC GEZE Ukraine
 E-Mail: office-ukraine@geze.com
 www.geze.ua

United Arab Emirates/GCC
 GEZE Middle East
 E-Mail: gezeme@geze.com
 www.geze.ae

United Kingdom
 GEZE UK Ltd.
 E-Mail: info.uk@geze.com
 www.geze.com

GEZE GmbH

Reinhold-Vöster-Straße 21–29
 71229 Leonberg
 Germany

Tel.: 0049 7152 203 0
 Fax: 0049 7152 203 310
 www.geze.com



Naziv

- Mehanički programski prekidač, okretni gumb, 1-struki okvir AS 500, alpin bijela, kat. br. 113226
- Mehanički programski prekidač, ključ, 1-struki okvir AS 500, alpin bijela, kat. br. 113227

Dodatna oprema

Naziv	Kat. br.
UP-okvir AS 500	
▫ 1-struk	115376
▫ 2-struk	115377
▫ 3-struk	115378
▫ 4-struk	115379
▫ 5-struk	115380
Nadžbukna kutija AS 500	
▫ 1-struka	120503
▫ 2-struka	128609
▫ 3-struka	133206
Međuokvir 55×55 za ST 550, alpin bijela	155851
Međuokvir 55×55 za LS990, alpin bijela	148997
Međuokvir 55×55 za LS 990, plemeniti čelik	131822
AS 500 slijepi pokrov BAB	118480

Prikladni programi prekidača

Jung

- AS 500
- LS 990 (s međuokvirom)
- ST550 (s međuokvirom)

Merten

- Sustav M

Berker

- B3
- B7
- S1

Gira

- Standard 55
- E2
- Događaj

Greška

- EDIZIOdue

Tehnički podatci

- Napon: 24 V DC
- Potrošnja struje: 50 mA
- Dužina voda, maks.: 100 m
- Tip zaštite: IP 40
- Skladištenje: -20 °C ... 85 °C
bez kondenzacije
- Temperatura okoline u pogonu: -15 °C ... 50 °C
- Otpornost na elektromagnetske smetnje prema: EN 61000-6-2

Nacrti s mjerama

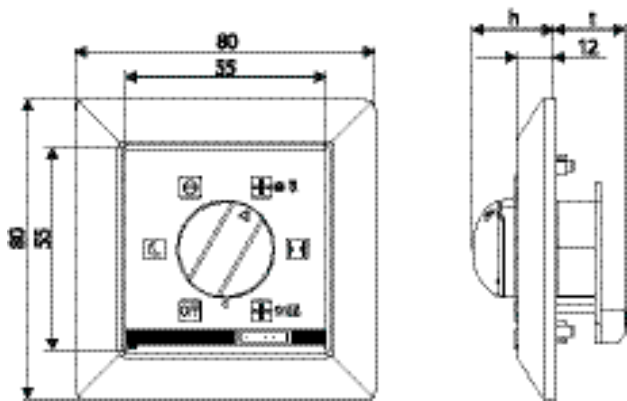

Sastavljanje

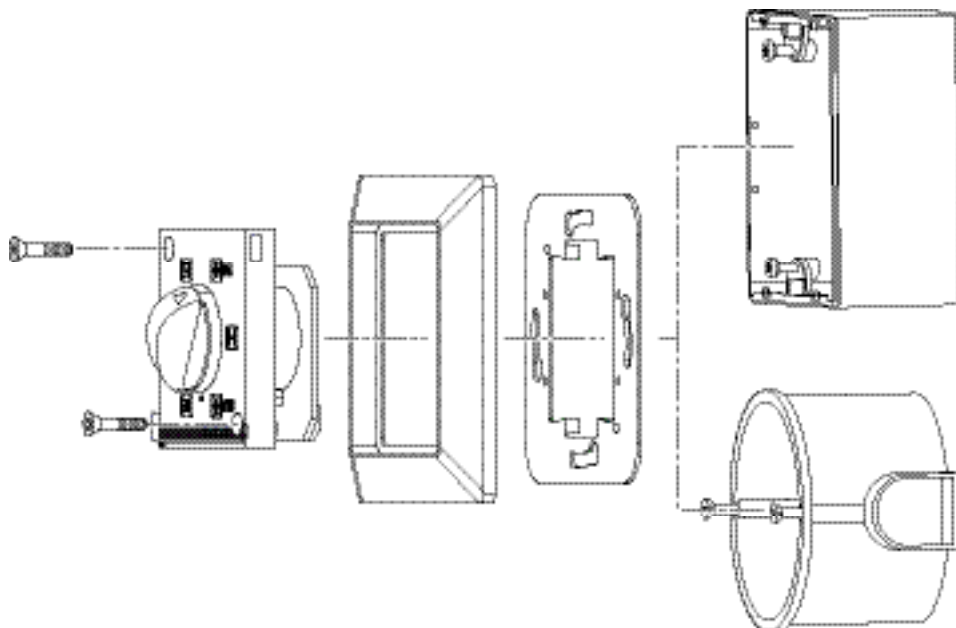

Šablona za montažu na stup







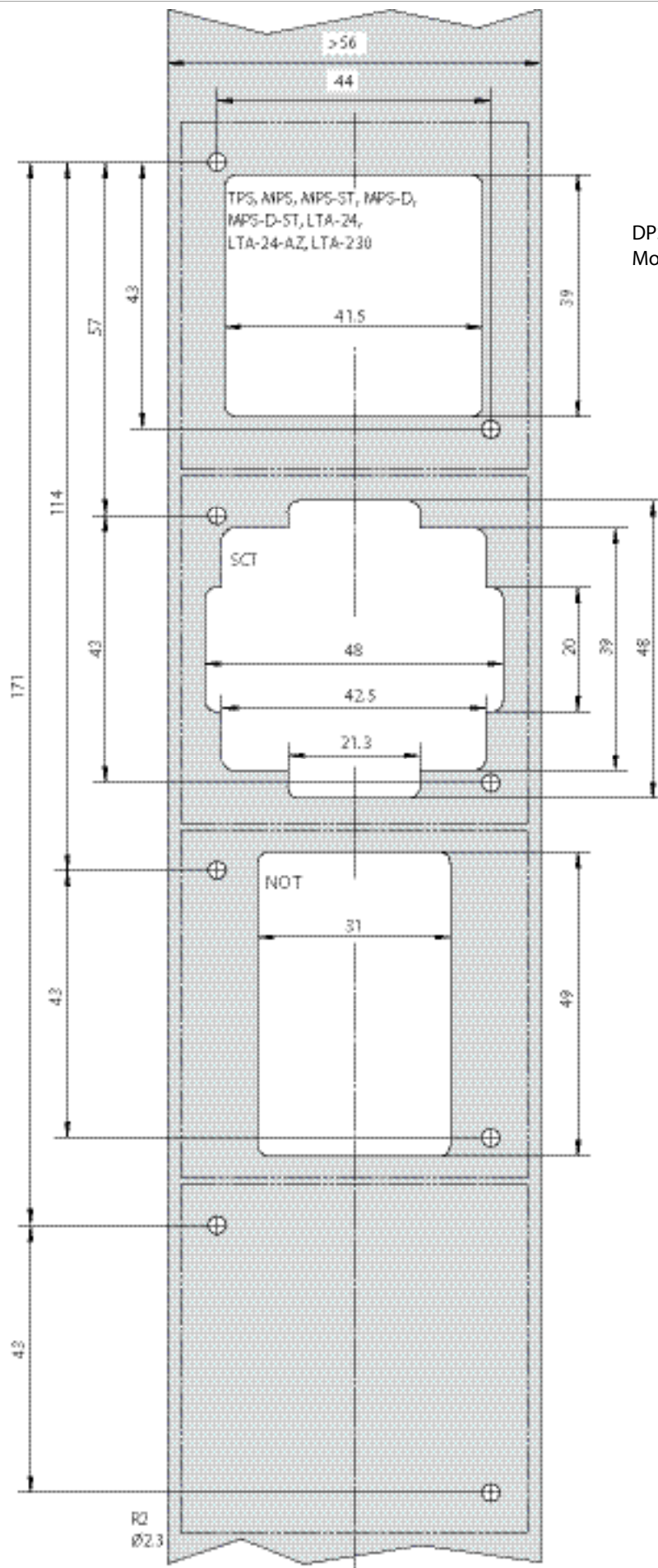

Dimenzije papirnate šablone mogu se promijeniti zbog vlage zraka. Stoga vrijede podatci o dimenzijama.

► Prije korištenja papirnate šablone provjeriti mjere i po potrebi ih ispraviti.

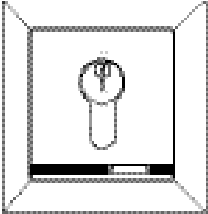
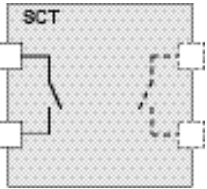

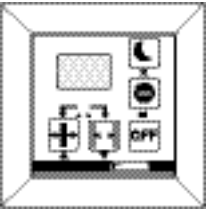
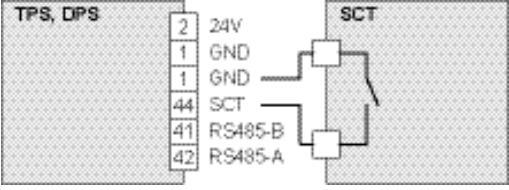
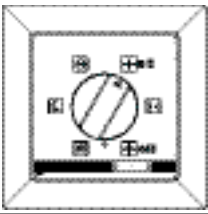
DPS, LTA-LSA:
Montaža na stup nije moguća.

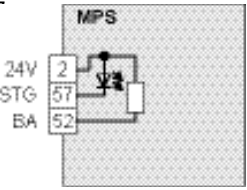
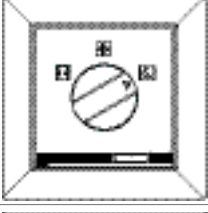
Spojne sheme

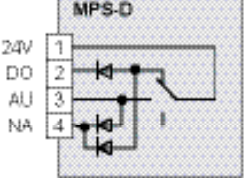
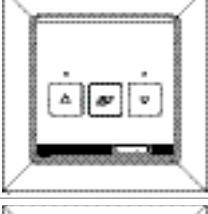
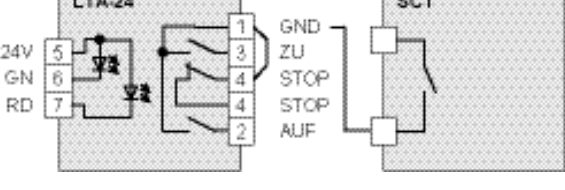
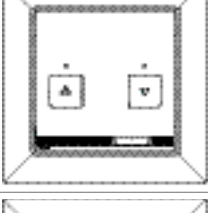
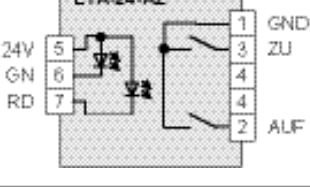
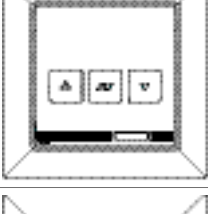
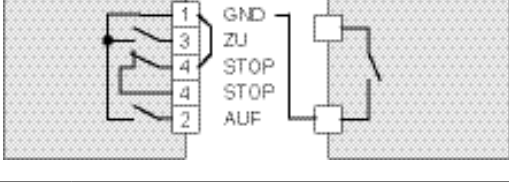
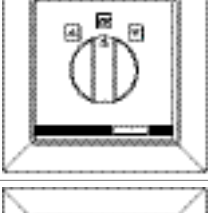
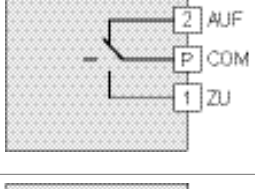
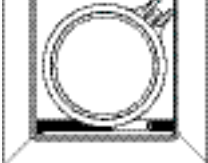
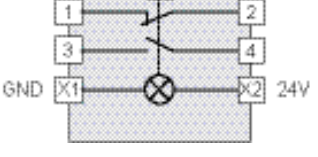
Prekidač	Naziv	Kat. br.	Prekidač	Naziv	Kat. br.	Spojna shema	h [mm]	t [mm]
	SCT (1-pol.)	117996		-	-		11	31.9
	TPS TPS-SCT TPS-KDT TPS-KDT-SCT DPS s OFF DPS bez OFF DPS s OFF SCT	113231 113232 126582 126583 151524 155809 155810					11.3	5.3 31.9
	MPS	113226		MPS-ST	113227		24	36
	MPS-D	118417		MPS-D-ST			24	36
	LTA-24 LTA-24-SCT	118473 127176					11	26
	LTA-24-AZ	129393					11	26
	LTA-230 LTA-230-SCT	118474 118475					11	26
	LTA-LSA	118476					24	32
	U SLUČAJU NUŽDE	123132					54	56